



## Awning Install Instructions



**Table of Contents**

**1 Getting Started ..... 3**

1.1 Product Contents:.....3

1.2 What You Need for The Install.....4

1.3 Tools Required.....4

**2 FITMENT STEPS ..... 5**

2.1 Unpacking & Preparation .....5

2.2 Awning Bracket Installation .....5

2.3 Awning Installation.....6

**3 Using & Caring For Your Awning ..... 8**

3.1 Before Use: .....8

3.2 Deploying & Packing Away:.....8

3.3 Cleaning Canvas & Bag:.....9

3.4 Cleaning Mould:.....9



1 GETTING STARTED

Thank you for purchasing this awning. The Bush Company have invested significant resources in terms of time and effort to ensure that your awning reaches the standards of quality, practicality, and reliability that The Bush Company is renowned for.

Before getting started with installation of your awning please make sure that the items listed below are present:

1.1 Product Contents:

180 XT Max:

- 1 x 180 XT Max Awning Aluminum structure.
- 1 x Awning canvas.
- 1 x Awning bag.
- 3 x Universal Awning L-Shape fitment brackets sets.
- 1 x Component list & fitment instruction.

270 XT:

- 1 x 270 XT Awning Aluminum structure.
- 1 x Awning canvas.
- 1 x Awning bag.
- 2 x Universal Awning L-Shape fitment bracket sets.
- 1 x Component list & fitment instruction.

270 XT Max:

- 1 x 270 XT Max Awning Aluminum structure.
- 1 x Awning canvas.
- 1 x Awning bag.
- 3 x Universal Awning L-Shape fitment bracket sets.
- 1 x Component list & fitment instruction.

If any of these items are not present, please contact the Bush Company immediately by email and we will send out the missing component. Please provide the serial number of your awning when communicating with The Bush Company, it is stamped on a plate on the frame of the awning.



## 1.2 What You Need for The Install

The Bush Company or one of our stockists can assemble and install your awning, but if you choose to install the awning yourself, please make sure that you have done the due-diligence on your intended install to ensure that it does not create any safety issues and ensure that you follow standard safety precautions when undertaking the install.

You may find it useful to watch the following videos:

[Awning To Tent and Awning Bag Install](#)

[What If Your Vehicle Has A Spoiler On The Rear Door](#)

Before installation, ensure that your hands and workwear are clean from oil, grime & dirt. Ensure that the correct tools and PPE are used whilst installing the awning.

## 1.3 Tools Required

The following tools are recommended for the install.

- 13mm ratchet spanners
- Ratchet with 13mm socket
- 5mm Allen Key
- Anti-seize grease (e.g.: Lanotec Type A-Grease or Nickel Anti-Seize)

**Please be aware that the awning is a heavy item and cannot be installed by 1 person.**

## 2 FITMENT PROCESS

### 2.1 Unpacking & Preparation

- ✓ Unpack all components from packaging, ensure that everything is accounted for as indicated in the fitment kit contents list.
- ✓ Do not use sharp objects when unpacking the awning as this can result in damage to the awning.
- ✓ Ensure that the designated area on the roof rack / load bars for the awning is free from any pre-fitted fasteners, brackets, or accessories.
- ✓ **Tip: all the bolts supplied are stainless steel so we recommend putting some anti-seize grease on all the bolts and only using hand ratchet tools to tighten the nuts slowly to prevent burring of the thread which can result in seized nuts.**

### 2.2 Awning Bracket Installation

- ✓ The Heavy Duty L Brackets are supplied with The Bush Company Awnings for fitment. If you require additional brackets depending on the fitment and the use of the vehicle/awning, these are available individually.
- ✓ Depending on your requirements and vehicle setup, you can assemble the Heavy Duty L brackets in the 'L' configuration for maximum height, or in one of two 'T' configurations as shown below.



- ✓ Place the Universal Awning L-brackets into the desired position on the roof rack/load bar and take a measurement between the brackets to ensure that they are space correct as **Figure 1** below shows.
- ✓ **IMPORTANT:** the gusset section of the awning **MUST** be fully supported underneath to prevent the bracket from failing. There **MUST** be bolts securing the bracket into the slots/holes closest to the edge of the load bar or rack. Failure to do this will result in the bracket failing due to excessive wind forces as the awning is free standing.

**Figure 1**

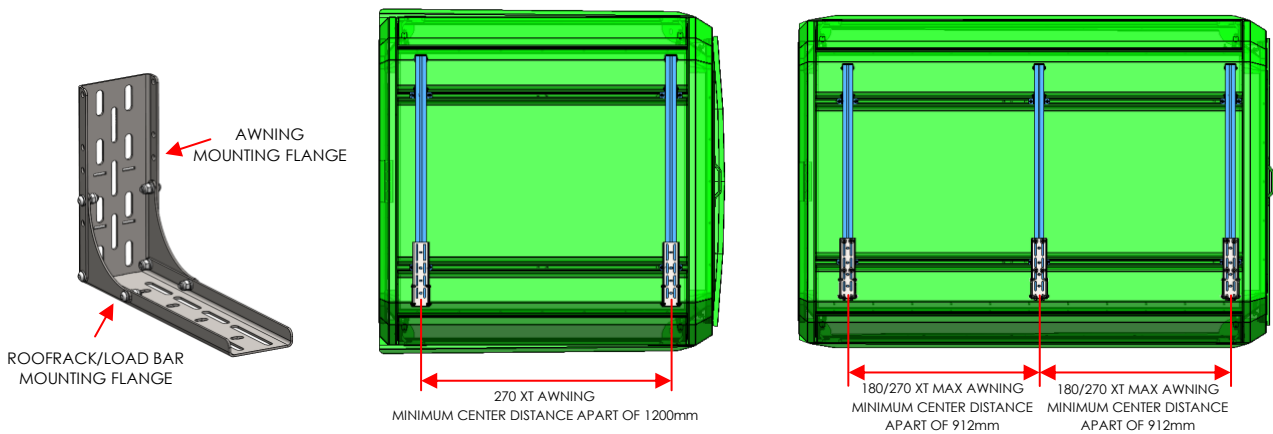

**PLEASE NOTE: BELOW ILLUSTRATIONS ARE BASED ON 3 X FITMENT BRACKETS USED FOR A 180-or-270 XT MAX. IGNORE THE CENTER FITMENT BRACKET IN BELOW ILLUSTRATIONS FOR A 270 XT AWNING.**

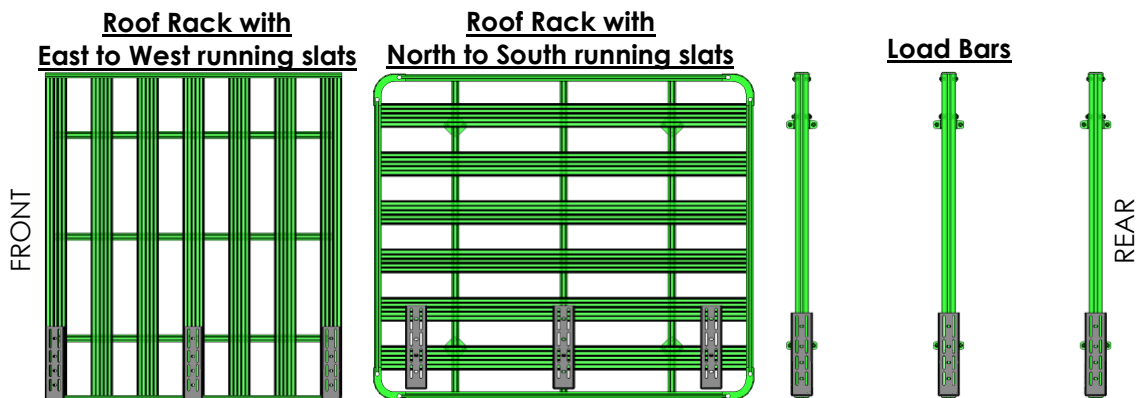

### 2.3 Awning Installation

✓ Slide the required M8 x 25mm fitment bolts into the rear side of the awning frame. **(Figure 2)**

**Figure 2**

**180 XT MAX AWNING**

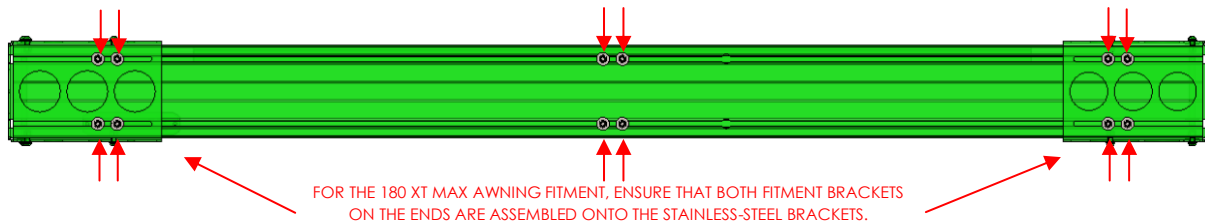

## Awning Fitment Instructions

### 270 XT AWNING

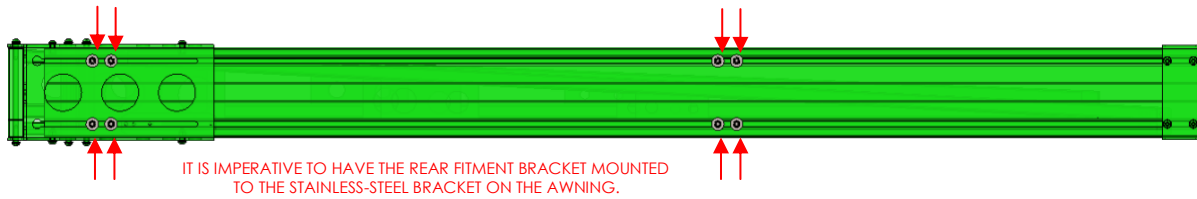

### 270 XT MAX AWNING

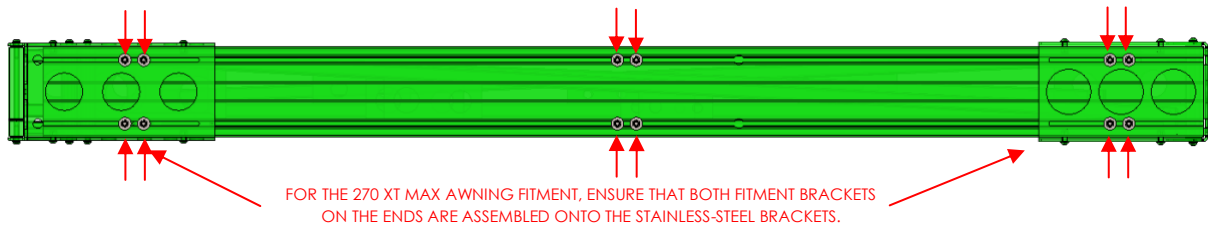

- ✓ Place the fitment brackets over the bolts to ensure that the bolts are spaced correctly. Position these brackets according to the dimensions taken previously. **All awnings must have a fitment bracket on the rear stainless-steel head stock of the awning (Figure 3), the 180 XT MAX and 270 XT MAX awning must also have a fitment bracket on the front stainless-steel head stock of the awning.**

**Figure 3**

### 180 XT MAX AWNING

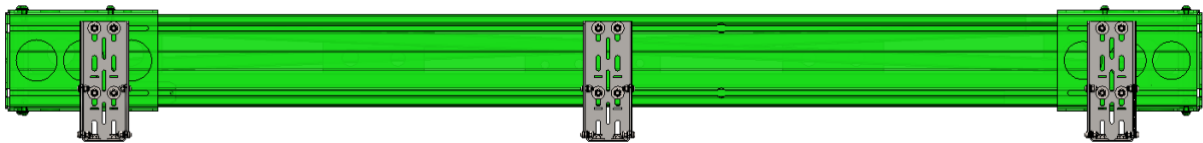

### 270 XT AWNING



### 270 XT MAX AWNING

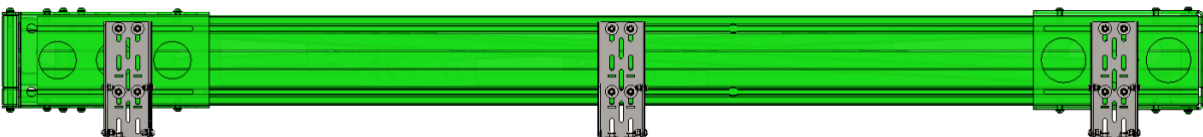

- ✓ Place the fitment brackets into position on your roof rack, as originally set up in step 2.2. If the position of the brackets is on an uneven surface, make use of packers to fill the uneven surface, large washers can be used. **(Figure 4).**

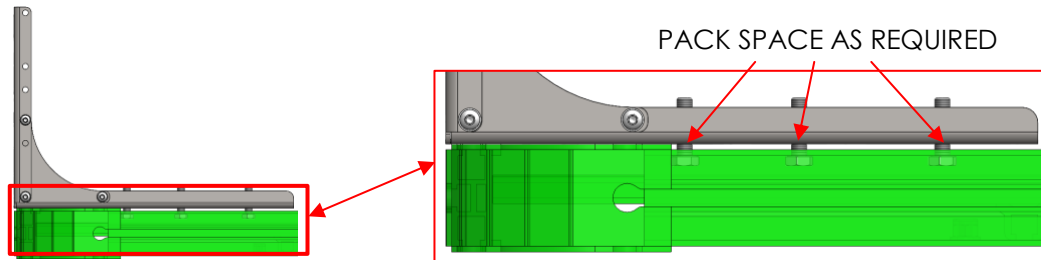
**Figure 4**

- ✓ Do not over tighten the bolts attaching the brackets to your rack/load bars, to allow for fine adjustment when aligning the bolts of the awning into the brackets.
- ✓ Once the brackets are fitted to the vehicle, we recommend '**test fitting**' the awning to the brackets on the vehicle at this stage (without the awning bag) to ensure that the bolts are in the correct position in the awning frame. Hold the awning in place by fitting some of the nuts on the rear of the brackets. Open out the awning to confirm that it is in the correct position and that when open it is clear of any obstructions such as tailgates etc.
- ✓ Lift the awning back down from the vehicle and place the awning into the awning bag with the bolts facing upwards and center the awning within the bag, making sure that the logo on the bag is facing outwards and the zipper is on the bottom side of the awning.
- ✓ Make an incision on the bag on top of each bolt. Ensure to make a small incision to still have to force the bag over the bolts. **This is a critical step, so make sure that the bolts have not moved in the channels of the awning before cutting the awning bag.**
- ✓ Load the awning (now in the bag) back onto the fitment brackets on the vehicle by aligning the bolts in the awning to the relevant holes in the fitment brackets. Fasten the awning to the brackets by means of a M8 x 24 washers and lock nut supplied with the bracket sets.
- ✓ Tighten all the fasteners across the fitment brackets.
- ✓ Ensure all the fasteners are properly fastened one last time.
- ✓ Completely erect the awning to ensure there are no obstructions.
- ✓ Enjoy your NEW The Bush Company XT Awning.

### 3 USING & CARING FOR YOUR AWNING

#### 3.1 Before Use:

We recommend that new awnings are thoroughly wet down before first use. This will ensure that your awning performs well in wet weather by allowing the poly/cotton corespun thread and canvas to swell ensuring the take up of any potential leaks in the stitching.

#### 3.2 Deploying & Packing Away:

- ✓ When deploying your awning if the canvas seems excessively tight, **STOP** and check that the canvas is not caught on the hinge mechanism and that it has not slid too far one way in the sail-track on the awning frame.





## Awning Fitment Instructions



- ✓ When packing the awning away, ensure that the canvas is not pinched between the awning arms especially close to the hinge mechanism.

### 3.3 Cleaning Canvas & Bag:

- ✓ Do not use soap or detergents on the canvas as this can result in colour leaching.
- ✓ To clean use a soft brush and cold water.
- ✓ Do not expose to petrol, oils or harsh chemicals.

### 3.4 Cleaning Mould:

Your awning canvas is pre-treated with mould and mildew resistance, but if mould/mildew does occur please follow these steps:

- ✓ Allow mould to dry.
- ✓ Remove surface mould off with stiff bristle brush.
- ✓ Vacuum the area.
- ✓ Treat area with Oil of Clove spray (diluted spray can be purchased or can be mixed using a few drops of oil into a spray bottle of water).

**THANK YOU FOR PURCHASING A XT AWNING AT THE BUSH COMPANY.**

**SHOULD YOU HAVE ANY QUERIES ABOUT THE FITMENT, FEEL FREE TO CONTACT US.**



T:+61 (0)7 5302 6948



[info@thebushcompany.com.au](mailto:info@thebushcompany.com.au)



[www.thebushcompany.com.au](http://www.thebushcompany.com.au)